

517, 528 and 529 Cabinet Knob Series

Finishes for Life
TARNISH-FREE GUARANTEED

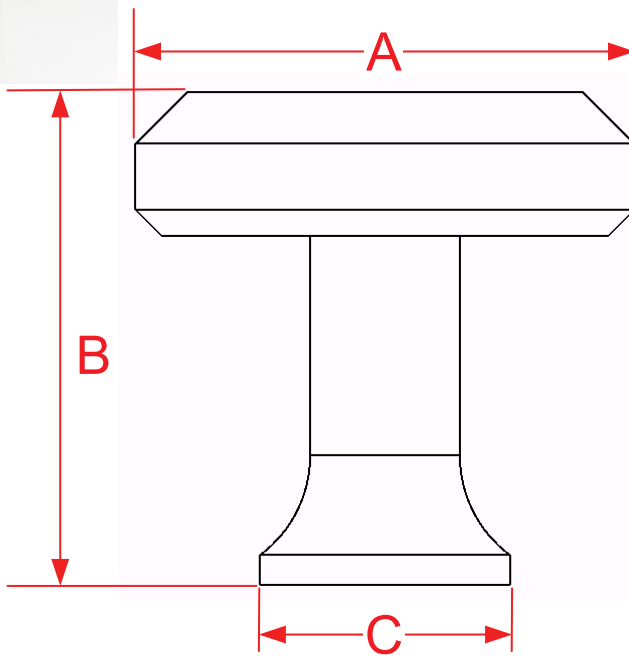

	A	B	C
Part #	Diameter	Projection	Base
517	1.0000"	1.0625"	0.5000"
528	1.2500"	1.2500"	0.6250"
529	1.5000"	1.2500"	0.6250"
Custom Sizing Available			



Manufacturing Fine Architectural Hardware
in the USA Since 1927



Copyright 2015
Colonial Bronze Company
All rights reserved
www.colonialbronze.com -
860.489.9233